

TAMAÑO MOTOR	63	71	80	90S	90L	100	112M	132S	132M			
KW	0.18	0.25	0.37	0.55	0.75	1.1	1.5	2.2	3.0	4.0	5.5	7.5
L3	223	245	278	304	328	350	380	425	461			
G	130	145	175	195	195	215	240	275	275			
L2	45	55	80	80	80	100	100	110	110			

TORQUE PERMISIBLE 600

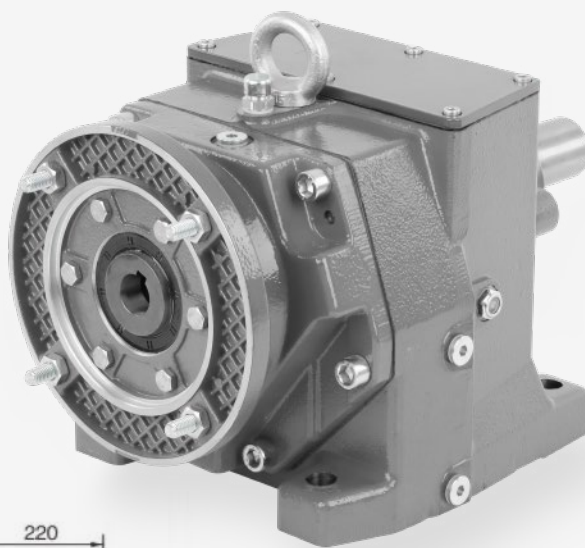

R67

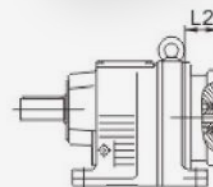
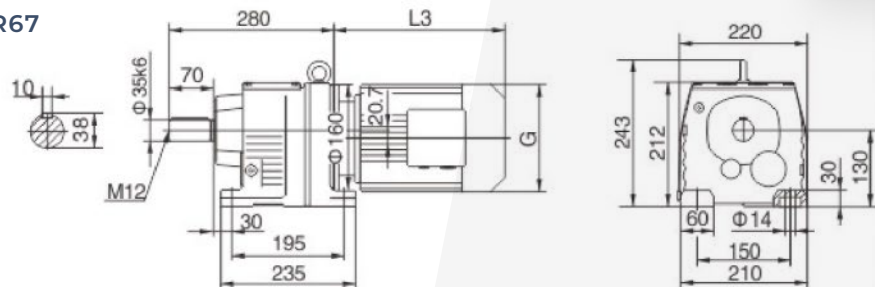

R..S67

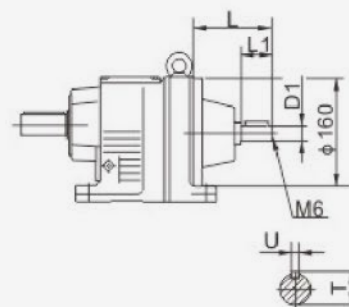

RF67

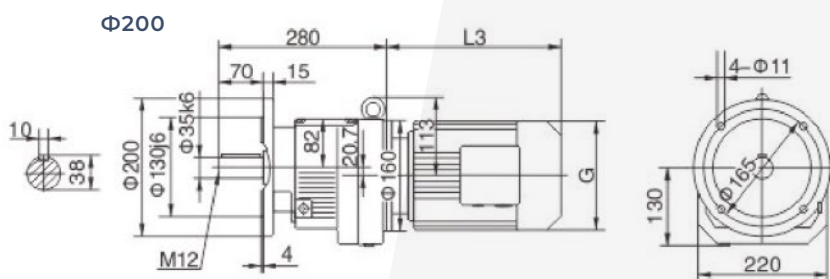

R..67R37

